

ECOLUZ

Una luz para el ambiente



Contacto: Luis Mora

Correo: luis.mora@ecoluz.cr

Telephone: (506) 8708-3322

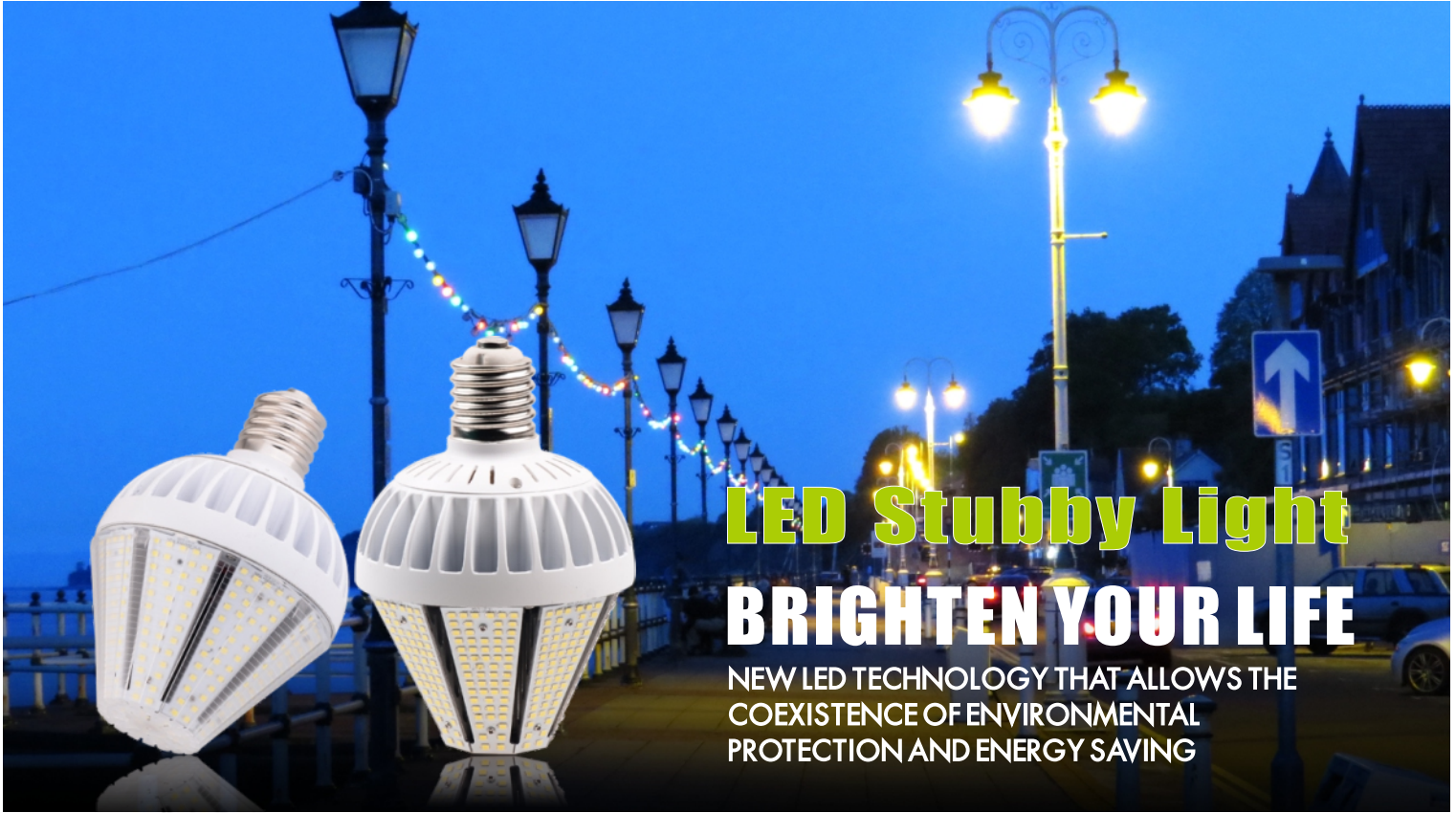

LED Stubby Light

BRIGHTEN YOUR LIFE

NEW LED TECHNOLOGY THAT ALLOWS THE COEXISTENCE OF ENVIRONMENTAL PROTECTION AND ENERGY SAVING

Benefits

1. MH/HPS/HID/MHL/CFL lamp retrofit
2. Screw Base Direct Install by bypass ballast
3. 100% Die Casting Heat Sink
4. Universal Base E26/E27/E39/E40
5. ETL CETL CE ROHS listed



Intertek
4010207

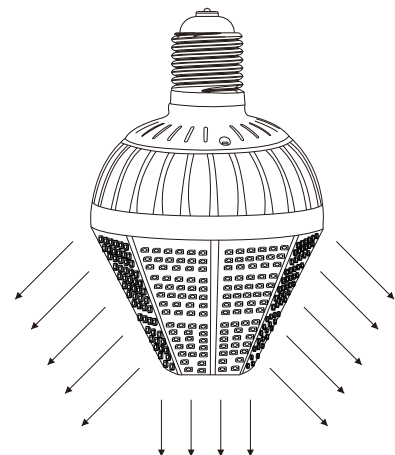

BB-HYD-XXX-D

Features

1. Beam angle:360 degrees.
2. Aluminum fins heat sinks and active air exchanging cooling system in order to speed up heat dissipation.
3. It's major to replace the CFL/MH/HID/HPS.
4. Green, energy saving, long and reliable life of 50,000 hours.
5. No RF interference, No IR/UV radiation ,no mercury pollution.
6. Wide colour availability in degrees Kelvin(K),2700-6700K.
7. Streamline exterior design, beautiful appearance.
8. Environment friendly ,energy saving (70~80%).
9. Special circuit design, each LED work separately, avoiding the single broken LED influence problem.

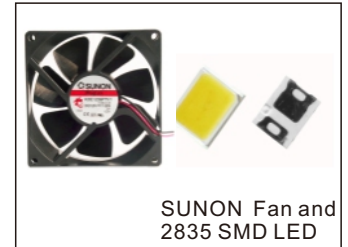

Application

- 1.Sports Lighting/Post Top Lighting.
- 2.Canopy Lighting.
- 3.High/Low Bay Lighting.
- 4.Roadway Lighting/Street Lighting.
- 5.Other applications.



SPECIFICATIONS

Power	30W	40W	50W	60W	80W
Model	BB-HYD-30W-D	BB-HYD-40W-D	BB-HYD-50W-D	BB-HYD-60W-D	BB-HYD-80W-D
Luminous Flux	3600lm	4800lm	6000lm	7200lm	9600lm
Replacement	HPS 100W	HPS 125W	HPS 150W	HPS 175W	HPS 250W
DLC certification (only -E39)	Pending	Y	Pending	Y	Pending
Light Source	SMD LED				
Luminous Efficacy	>120lm/w				
Operation Temp.	-40 to +45°C				
CCT	2700K SW / 3000K WW / 4100K NW / 5000K DW / 5700K CW				
CRI	80+				
Life Span	50,000 hours at 25°C				
Voltage	100-277VAC/50-60HZ				
Driver	Internal Power Supply				
Dimming	NO				
Beam Angle	360°				
Lamp Base	E26/E27/E39/E40				
PF	>0.95				
Warranty	5Years				

DIMENSIONAL DRAWING

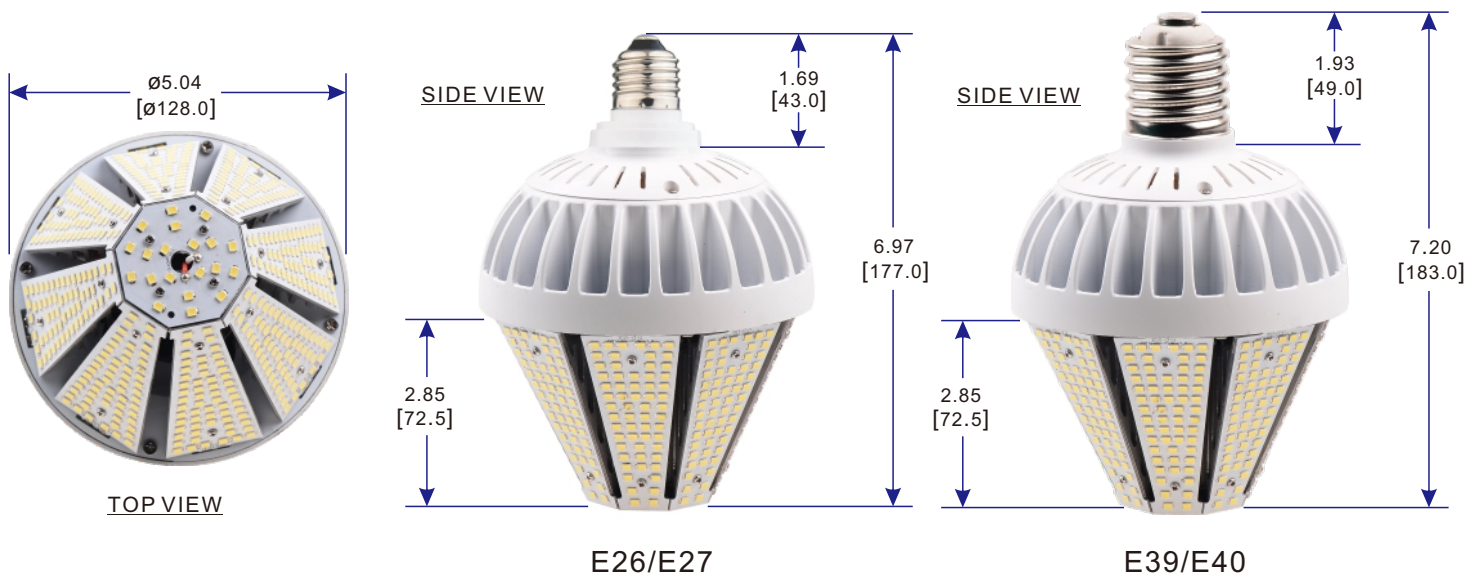

Notes:

1. All Dimensions are in Inches [Millimeters].

LUMINOUS INTENSITY DISTRIBUTION

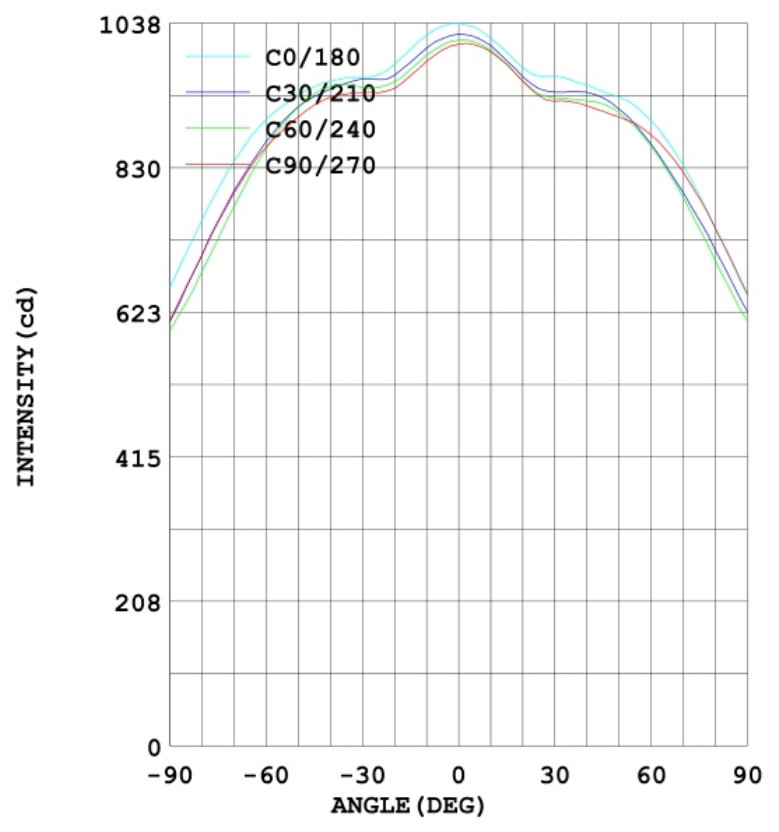
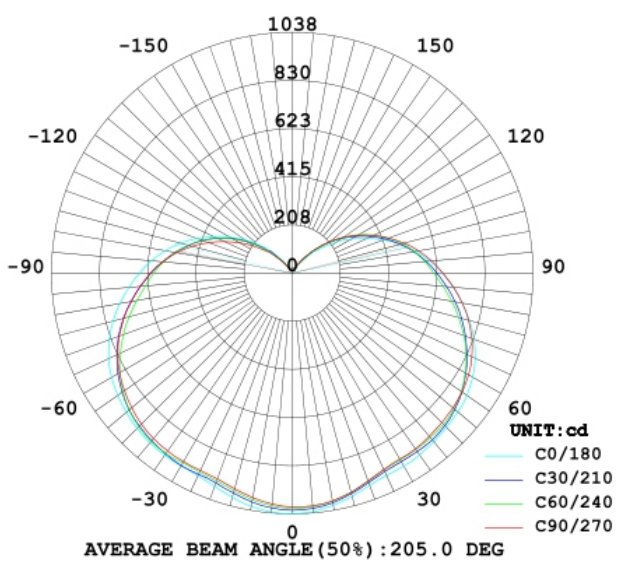

PROJECTS

By using our 60W LED Stubby Bulb to replace 175W Metal Halide bulb for canopy lighting fixtures, the customer is now able to save a lot per month from his electric bill.



Replace
→



60W LED = 175W MH

Note:

- Don't take the LED lamp apart.
- The LED lamp must work under the right voltage according to the specification.
- Must remove the Ballast,Capacitor,Ignitor before installing our LED Light.

UNIQUE DESIGN

The design of this lamp is very beautiful and Unique, Main Material is used aluminum which is perfect material for thermal conductive to expedite air exchange .

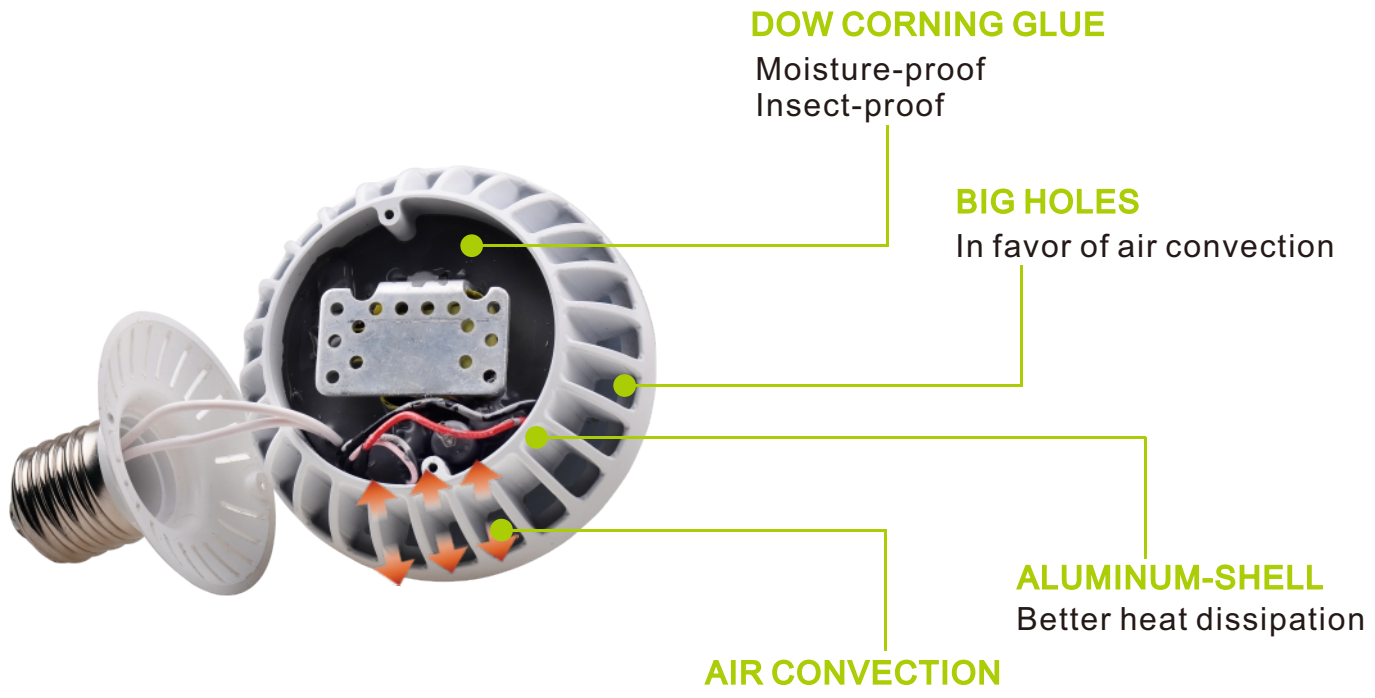

POWER SUPPLY DETAILS

The power supply is built with high quality brand chips ,it has the following advantages:

- Good heat dissipation : pure aluminum structure which is conducive to heat dissipation;
- High efficiency :low power consumption.generate low heating, which can reduce lighting temperature, thereby improving efficiency;
- Temperature protection:when lamp temperature go rising ,power supply can be sensed and automatically ajust power to low temperature ,to enhance the whole lamp lifespan;
- Surging protection :it can suppress surge invasion to protect the lamp from damage.

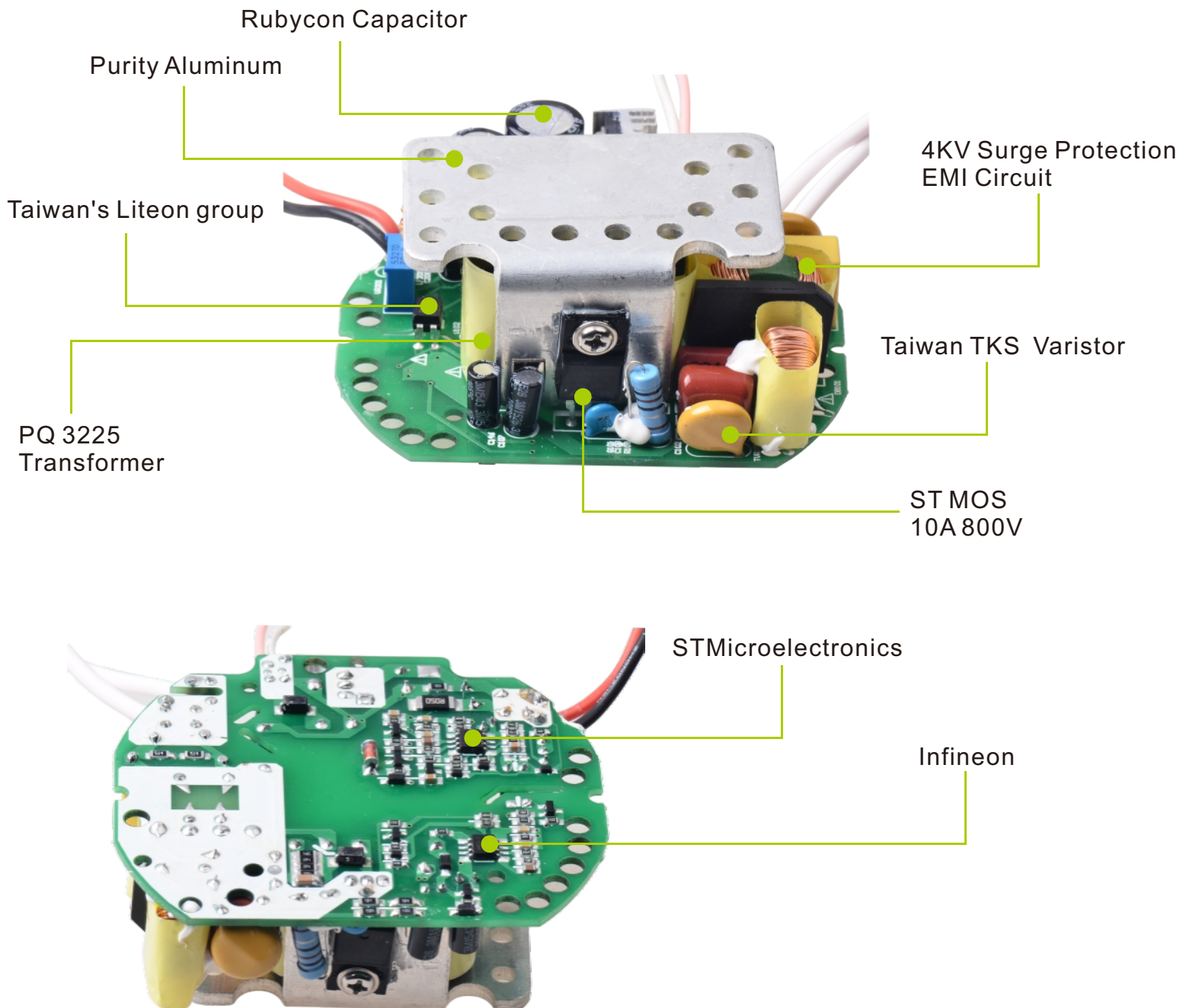

INSTALLATION

Normally. The traditional lamp has the ballast or capacitor or ignitor, like HPS, MH.

Replace E40/E27 CFL

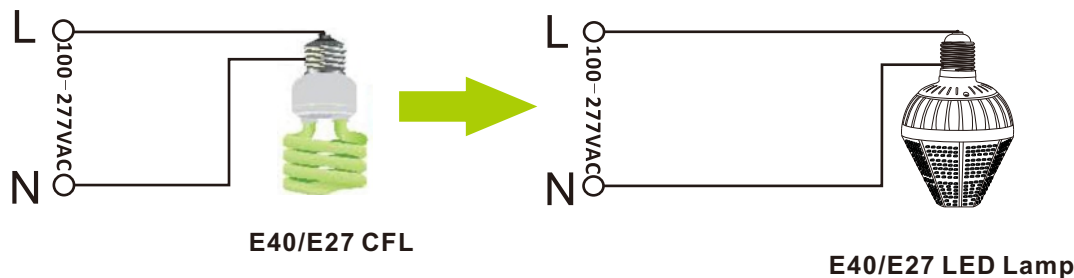

Replace HPS/MH

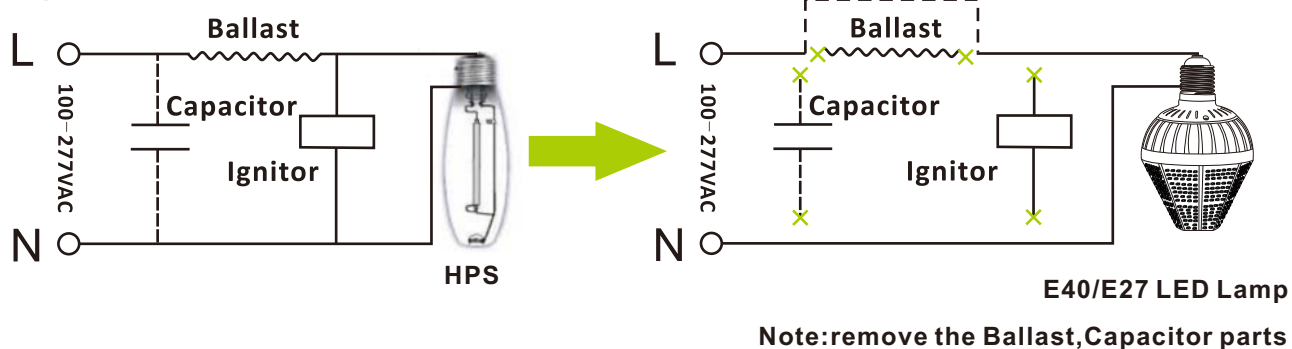

When LED Stubby Light installed in enclosed fixture, please make sure fixture diameter big enough for heat dissipation.

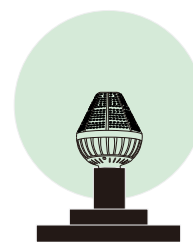

PACKING INFO



Packaging	Carton Size(mm) (L*W*H)	N.W	G.W	Volume weight
12pcs/CTN	500*480*360mm	9.0kg	9.8kg	18.0kg