



# LED AREA SERIES POST TOP



## PRODUCT DESCRIPTION

The area series has the high-performance solution for the most demanding applications within a unique design. With different precision refractive optical lens and an easy-install design, it can be used in many applications such as pedestrian street, factory, schools, garden, courtyard, hotel, parking lot, public parks etc.

## FEATURE

1. Air cooling Design
2. IP67 Rated Enclosure
3. Post top or Pendant Mounting
4. Superior Low-glare Illumination
5. Optional with Photo Cell
6. Optional Black, White or Bronze color

\*If the customer does not specify a requirement, the inner diameter defaults to 62mm.

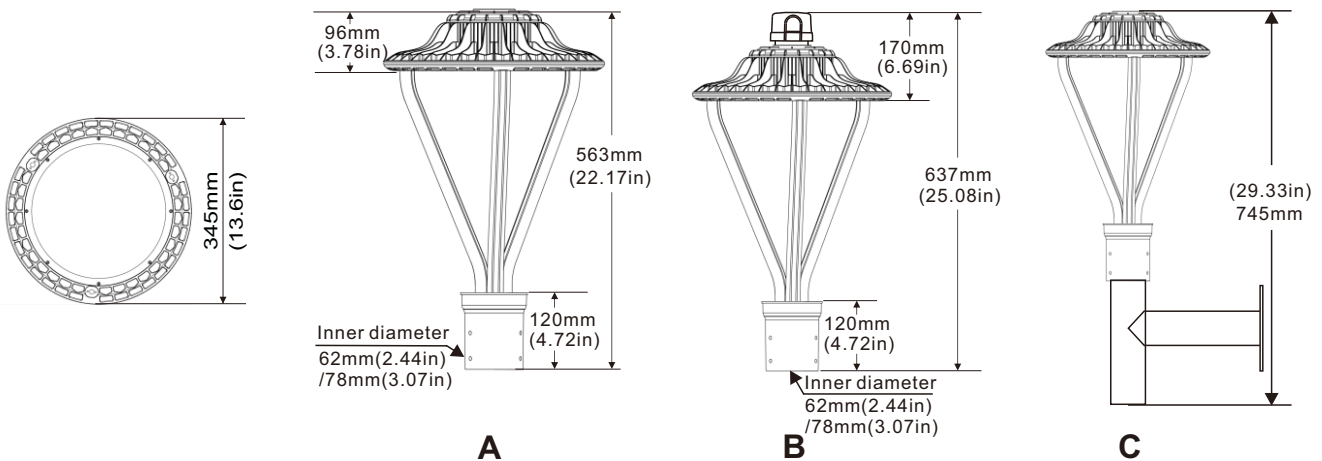

## Ordering Information

Area Series	Watts	Version	CCT	Voltage	Control	Installation	Beam Angle	Color
BB-LD	30W	AR-B	WW-3000K	Blank-100-277VAC	Blank - without control	Blank- 2.4"(62mm)pole	Blank-Type V	Blank - bronze
	50W		NW-4100K	HV-200-480VAC	MS - Motion Sensor	P1- 3"(78mm)pole	T2-Type II	WH - white
	75W		DW-5000K		PC - Photocell Sensor		T3-Type III	BC - black
	100W		CW-5700K				T4-Type IV	
	150W							

Notes:

1. 130lm/w, 150lm/w is optional, the default is 130lm/w.
2. Customers can choose a lamp with a baffle as needed.

Special Order-Ask Customer Service

## PERFORMANCE DATA

Power	30W	50W	75W	100W	150W
Model	BB-LD-30W-AR-B (-A/-B/-C/-D)	BB-LD-50W-AR-B (-A/-B/-C/-D)	BB-LD-75W-AR-B (-A/-B/-C/-D)	BB-LD-100W-AR-B (-A/-B/-C/-D)	BB-LD-150W-AR-B (-A/-B/-C/-D)
Luminous Flux	3900lm	6500lm	9750lm	13000lm	19500lm
Replacement	HPS 100W	HPS 175W	HPS 200W	HPS 300W	HPS 500W
Light Source	SMD LED				
Luminous Efficacy	130lm/w 150lm/w available				
Color	Bronze,Black,White(If the customer does not request, the default color is bronze)				
Cover	Frosted cover				
Accessories	Options: A.Pole bracket B.With Sensor C.Wall bracket D.Wall a baffle				
DLC Certification	Type A DLC Listed				
Operation Temp.	-40 to +45°C				
CCT	2700K SW / 3000K WW / 4100K NW / 5000K DW / 5700K CW				
CRI	80+				
Life Span	50,000 hours at 25°C				
Voltage	100-277VAC/50-60HZ				
Driver	UL listed power supply				
Dimming	No				
With Sensor	Daily sensor available				
Beam Angle	120°				
IP	67				
PF	>0.95				
Warranty	3/5 Years				

## PROJECTS

By using our 100W Area Light to replace 300W Metal Halide bulb for parking area lighting fixtures, the customer is now able to save a lot per month from his electric bill.



Notes:

1. Don't take the LED lamp apart.
2. The LED lamp must work under the right voltage according to the specification.

## LUMINOUS INTENSITY DISTRIBUTION

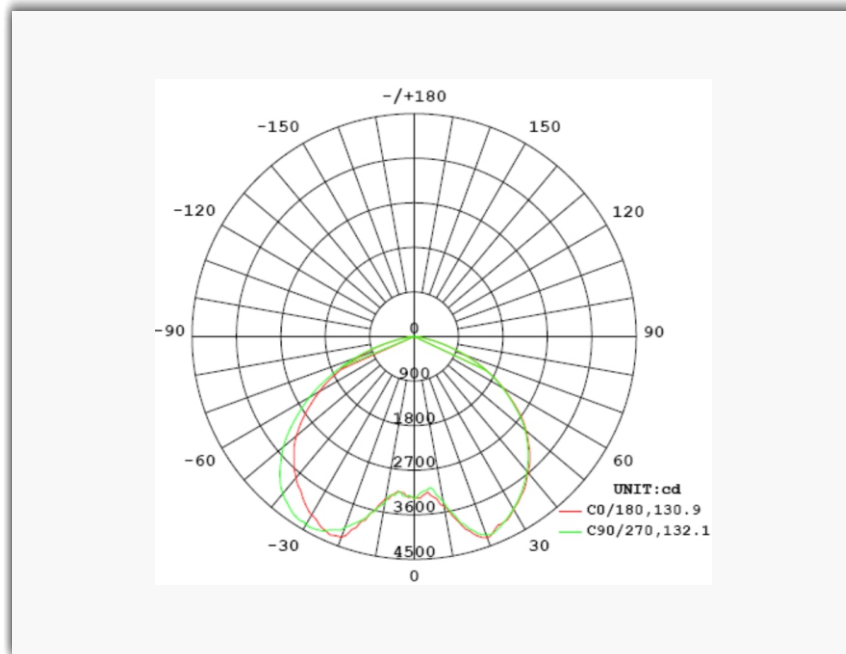

## APPLICATION

- Courtyard lighting
- Public parks lighting
- Street scapes lighting
- Parking areas lighting
- Hotel lighting



Street scapes lighting



Hotel lighting



Public parks lighting

## INSTALLATION

### Fixture assembly

- Feed the (3) Housing wires through one of the three Rods.
- Clip the (3) Rods onto the Housing. Be sure the Housing clips are properly engaged onto the Rods.
- Feed Fixture Wires through the Tenon Pole Adaptor.
- Slide Tenon Pole Adaptor on three Rods. Be sure the notches face the inside of the Tenon Pole Adaptor.
- Tighten the (3) Set Screws at the Tenon Pole Adaptor to secure Rods.

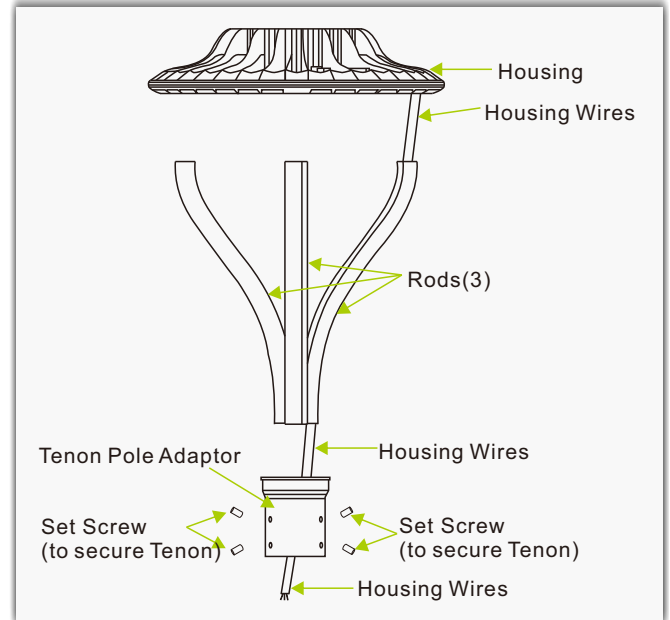

### Pole mounting

- Turn off the power before installation.
- Wiring right in the wiring box ("Black" is connected to "L", "White" connect to "N", "Green" to "Ground") and set the lamp into the bracket by the hole. (picture1).
- We should fasten the four screws with a hex wrench, and finished (picture2).

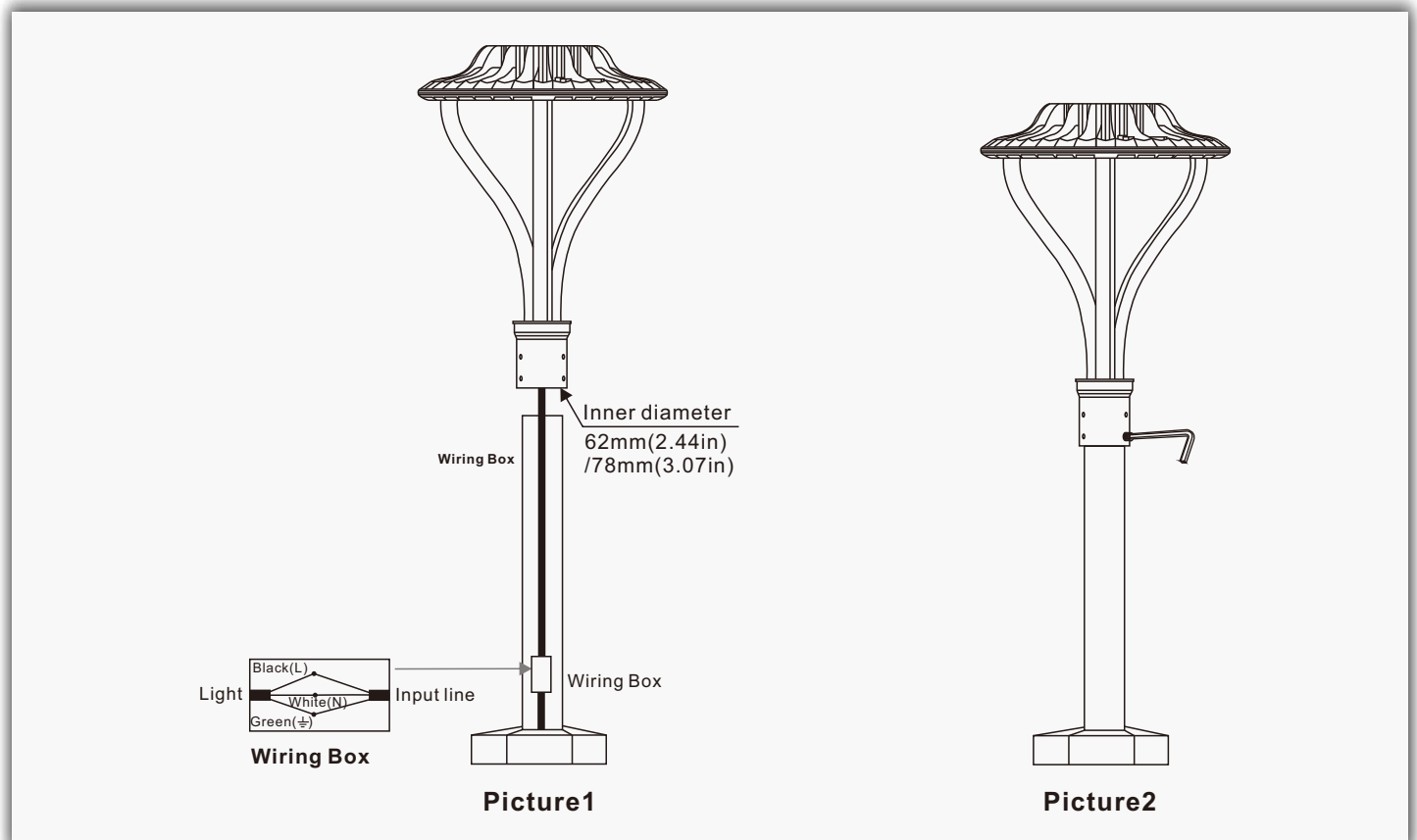

## Wall mounting



## Wiring

- Connect the black fixture lead to the (+) LINE supply lead.
- Connect the white fixture lead to the (-) COMMON supply lead.
- Connect the green Ground wire from fixture to supply ground.

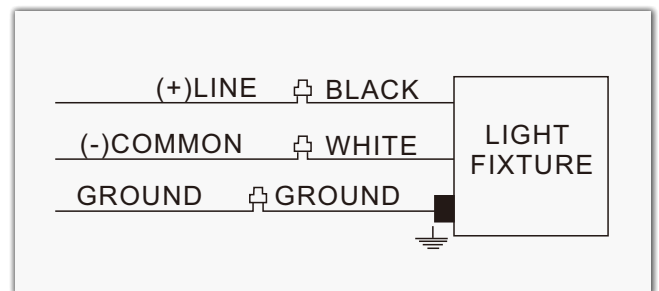

## Optional Accessories

Unit: in(mm)

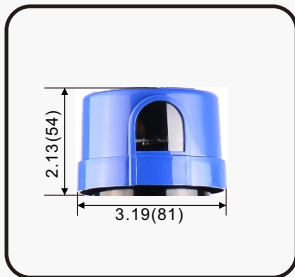

Photoelectric Control

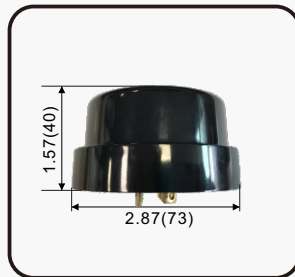

Short Cap



Motion Sensor

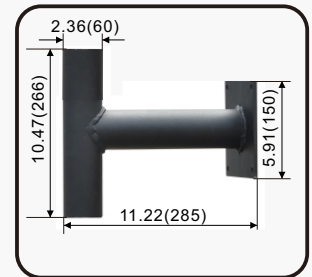

Wall Bracket

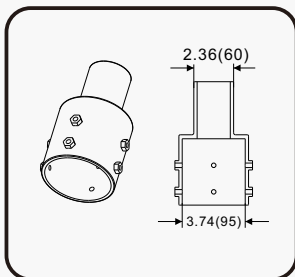

MGD03(2.4" to 3.5" round pole)

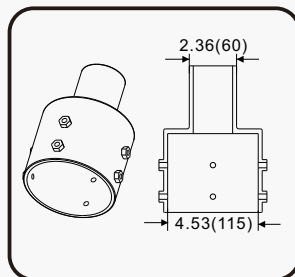

MGD04(2.4" to 3" square or 4" round pole)

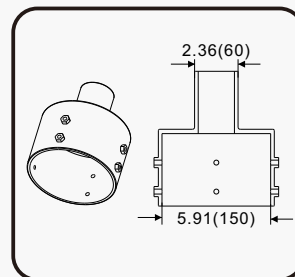

MGD08(2.4" to 4" square or 5.5" round pole)

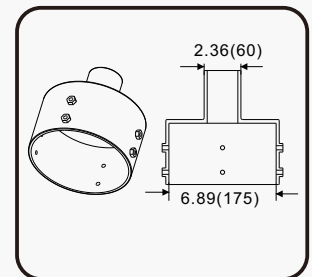

MGD09(2.4" to 6.5" round pole)

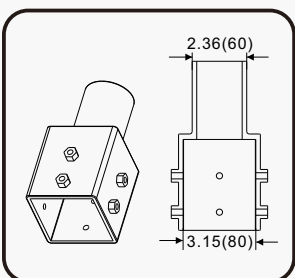

MGD10(2.4" to 3" square pole)

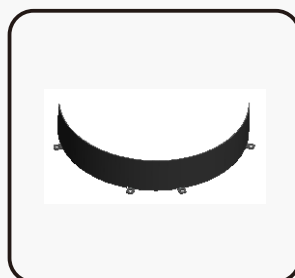

Baffle



With a Baffle

## PACKING INFO



Item	Packaging	Carton Size(mm) (L*W*H)	N.W	G.W	Volume weight
Lamp	1pc/CTN	17.3"X15.0"X7.9" 440*380*200mm	11.0 lbs 5.0kg	13.9 lbs 6.3kg	15.4 lbs 7.0kg
Wall bracket	1pc/CTN	14.2"X10.4"X7.3" 360*265*185mm	5.1lbs 2.3kg	8.2 lbs 3.7kg	10.2 lbs 4.6kg